

Baterías

Baterías selladas PHASAK de **plomo-ácido de 12V** disponibles en **7.2, 9, 12 y 18 Ah**. Compatibles con los modelos de SAI/UPS PHASAK que incorporen baterías de las mismas características.

Baterías estándar compatibles con cualquier producto que utilice baterías con características eléctricas similares.



- **Robustas, de calidad y seguras. Válidas para todo tipo de aplicaciones. Baja auto-descarga y larga vida útil**
- **Baterías selladas PHASAK de plomo-ácido de 12V disponibles en 7.2 Ah, 9 Ah, 12Ah y 18 Ah**
- **Baterías estándar compatibles con cualquier producto que utilice baterías con características eléctricas similares**
- **Compatibles con los modelos de SAI/UPS PHASAK, que incorporen baterías de las mismas características**

12V SIN
Mantenimiento





PHB 1207

Voltaje Capacidad
12V 7.2Ah
 151 x 94 x 65



PHB 1209

Voltaje Capacidad
12V 9.0Ah
 151 x 94 x 65



PHB 1212

Voltaje Capacidad
12V 12Ah
 151 x 95 x 98



PHB 1218

Voltaje Capacidad
12V 18Ah
 181 x 167 x 77



Todos los SAIS PHASAK están equipados con **baterías estándar de 12V** intercambiables.

www.phasak.com



PHB 1207

Baterías Selladas PHASAK de Plomo-Ácido de 12V
 Baterias Seladas PHASAK de Chumbo-Ácido de 12V
 PHASAK Sealed Lead-Acid Batteries 12V
 EAN: 5605922004423

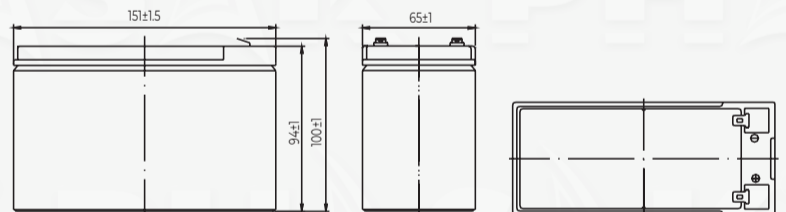

Datos Técnicos / Dados Técnicos / Technical Data

Referencia / Referência / Reference	PHB 1207
Voltaje Nominal / Tensão Nominal / Nominal Voltage	12 V
Capacidad Nominal / Capacidade Nominal / Rated Capacity	7.2 Ah
Tipo de Terminal / Tipo de Terminal / Terminal Type	T2/T1
Dimensiones / Dimensões / Dimensions	
Longitud / Comprimento / Length	151 ± 1 mm
Ancho / Largura / Width	65 ± 1 mm
Alto / Altura / Height	94 ± 1 mm
Altura Total / Altura Total / Total Height	100 ± 1 mm
Peso / Peso / Weight	~2.2 Kg
Capacidad / Capacidade / Capacity	
10h (10.5V) - 6.8 Ah / 1h (9.6V) - 4.7 Ah	
Resistencia Interna (100% Carga - 25°C)	
Approx.20m Ω	
Capacidad afectada por temperatura (20h)	
40°C (102%) / 25°C (100%) / 0°C (85%) / -15°C (65%)	
Auto descarga (25°C) / Auto Descharge (25°C) / Self Discharge (25°C)	
≤ 3 % / Month	
Temperatura Nominal de Funcionamiento / Temperatura Nominal de Funcionamento / Nominal Operating Temperature	
25°C ± 3°C (77°F ± 5°F)	
Voltaje de Carga Flotante (25°C) / Tensão de Carga Flutuante (25°C) / Float Charging Voltage (25°C)	
13.50V - 13.80V, -18mV/°C (temperature compensation)	
Corriente de Carga Cíclica / Corrente de Carga Cíclica / Cyclic Charging Current	
14.50V - 15.00V, 25°C ± 3°C (77°F ± 5°F) (temperature compensation)	
Corriente Máxima de Carga / Corrente Máxima de Carga / Maximum Charging Current	
2.16 A	
Corriente Máxima de Descarga / Corrente Máxima de Descarga / Maximum Discharge Current	
108 A (5s)	
Vida Útil de Flotación Diseñada / Vida Útil de Flutuação Projetada / Designed Floating Life	
5 años / anos / years	

www.phasak.com



Discharge characteristics

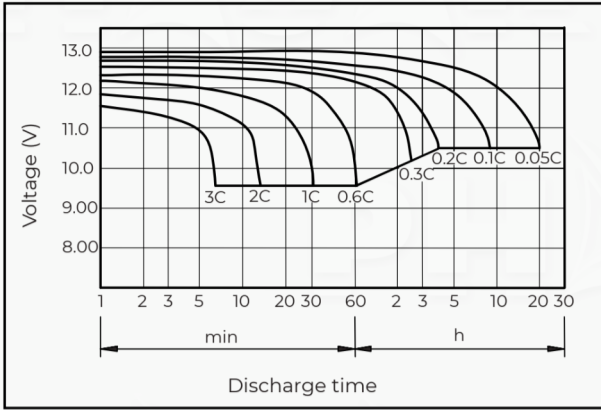

Chargind characteristics

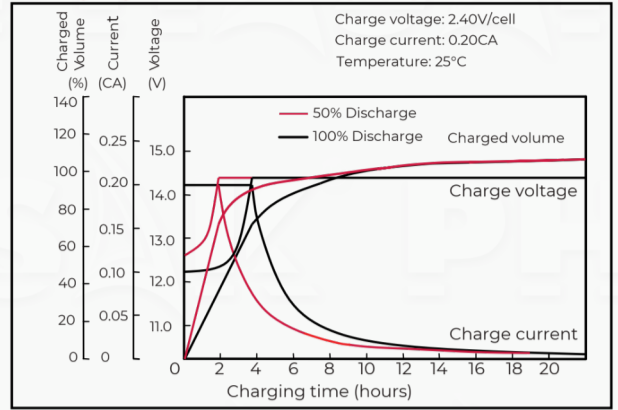

Effect of temperature on capacity

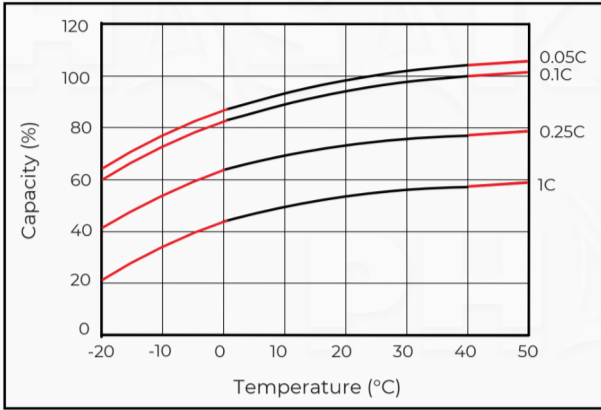

Self-discharge characteristics

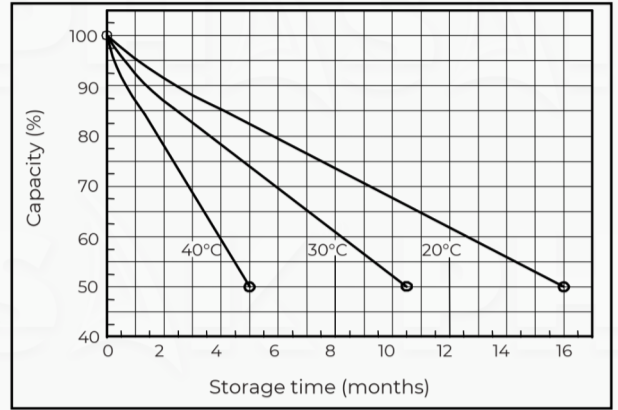

Floating life on temperature

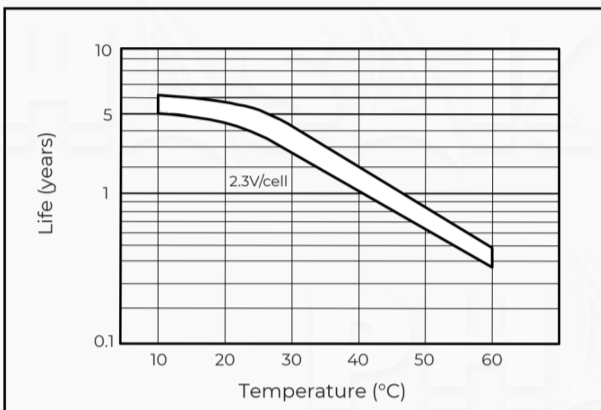

Cycle life on D.O.D(25°C)

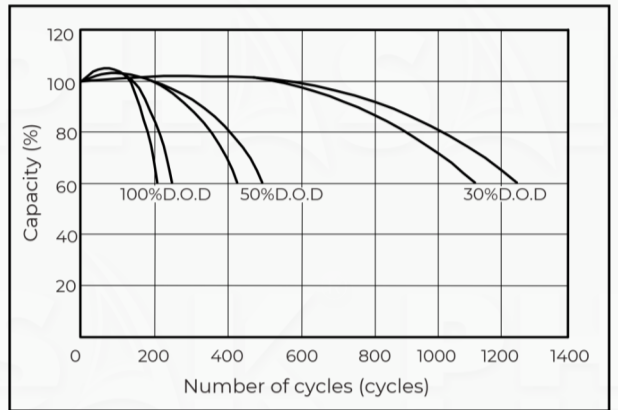

Relation for OCV and Capacity (25°C)

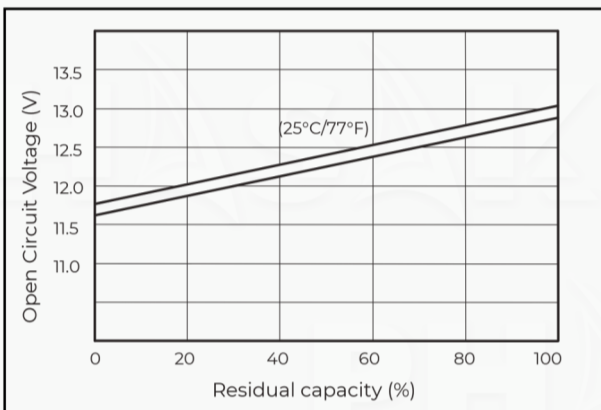

Relation Charging voltage / Temperature

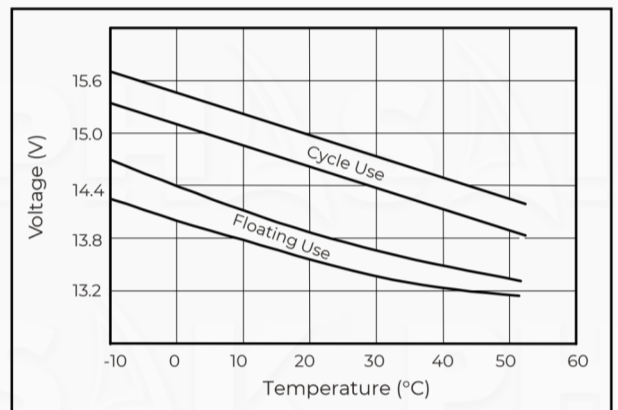

www.phasak.com



Terminal Type (mm)

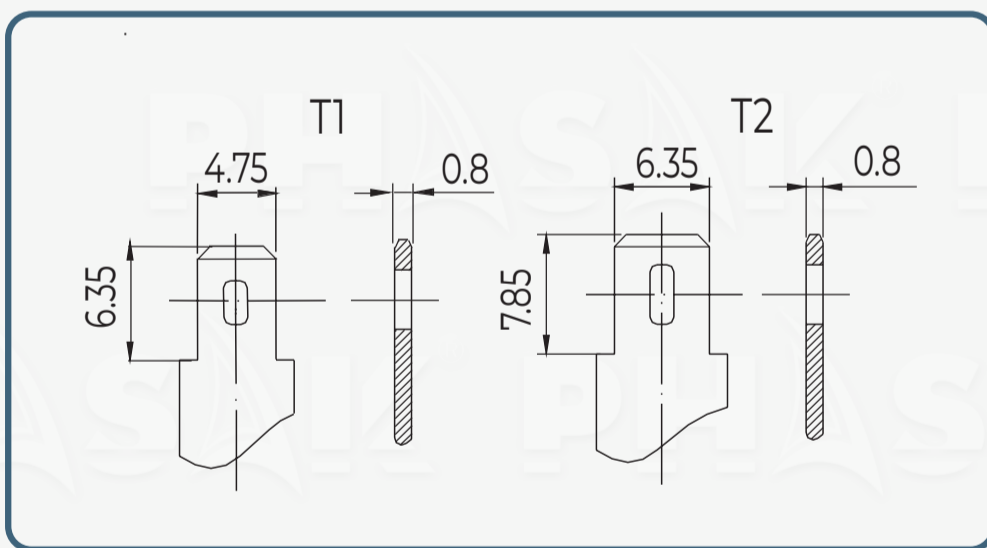

Construction

Component	Positive Plate	Negative plate	Container	Separator	Electrolyte	Safety valve	Terminal
Raw material	Lead dioxide	Lead	ABS (V-0 opt.)	AGM	Sulfuric Acid	Rubber	Copper

Constant current discharge characteristics at 25°C

(Ampere/battery)

F.V/Time	5min	10min	15min	30min	60min	2hr	3hr	4hr	5hr	10hr	20hr
9.60V	27.9	17.7	13.8	7.77	4.78	2.62	1.81	1.50	1.27	0.69	0.37
9.90V	27.0	17.1	13.5	7.62	4.71	2.60	1.80	1.49	1.27	0.69	0.37
10.2V	25.9	16.4	13.0	7.39	4.59	2.58	1.79	1.48	1.26	0.69	0.37
10.5V	24.8	15.7	12.5	7.21	4.50	2.54	1.77	1.47	1.25	0.68	0.37
10.8V	23.4	14.8	11.9	6.94	4.36	2.47	1.72	1.42	1.21	0.67	0.36

Constant power discharge characteristics at 25°C

(Watts/battery)

F.V/Time	5min	10min	15min	30min	60min	2hr	3hr	4hr	5hr	10hr	20hr
9.60V	311	199	157	89.1	55.4	30.6	21.5	17.8	15.2	8.30	4.45
9.90V	302	193	154	87.3	54.5	30.4	21.4	17.7	15.1	8.26	4.43
10.2V	289	185	148	84.6	53.2	30.1	21.2	17.6	15.0	8.22	4.41
10.5V	277	177	143	82.6	52.1	29.7	21.1	17.5	14.9	8.17	4.38
10.8V	261	167	135	79.6	50.5	28.9	20.4	17.0	14.5	8.01	4.29

The above characteristics represent average values and can be obtained within three charge and discharge cycles. The batteries must be fully charged before testing. The data in this document is subject to change without notice and become contractual only after written confirmation. Please contact NPP Power for the latest available version.



Compliant to: EUROBAT, RoHS, WEEE's and Reach.
Manufactured according to IEC 60896-21 / 22

www.phasak.com

